

### FEATURES

- Specific design for pulse signals
- Accommodate a variety of pulse formats
- High pulse fidelity

### APPLICATIONS

- Pulse generation
- Pulse picking
- Spectroscopy
- Lidar

### OPTIONS

- Heat-sink
- Custom design: higher PW, lower PRF

The DR-PL-10-MO RF drivers are amplifiers module designed to drive LiNbO<sub>3</sub> optical modulators so as to generate undistorted optical pulses.

Electrical pulsed signals differ from classical telecom signals by long periods with no signal, when telecom signals are usually well balanced in 1 and 0. They also differ from analog signal by a wider frequency content. In order to generate clean optical pulses with sharp edges, sustained high and low levels and no overshoot, pulsed signals do require specific amplifiers.

The DR-PL-10-MO driver is optimized for low and high Pulse Repetition Frequency (PRF) signals from 10 Hz to GHz. The bandwidth up to 10 GHz accommodates 100 ps narrow pulse width with short rise and fall time (down to 25 ps) and can withstand longer pulses up to 100 ns.

The DR-PL-10-MO drivers come in compact connectorized modules that match directly with Photline modulators, they use a single voltage power supply for ease and safety of use and feature an output voltage control for maximum flexibility. An optional heat sink is proposed as an accessory.

### Performance Highlights

| Parameter                  | Min   | Typ | Max   | Unit            |
|----------------------------|-------|-----|-------|-----------------|
| Cut-off frequencies        | 45 k  | -   | 8 G   | Hz              |
| Output pulse amplitude     | 2.5   | -   | 8.5   | V <sub>pp</sub> |
| Gain                       | -     | 21  | -     | dB              |
| Pulse repetition frequency | 10    | -   | 1 G   | Hz              |
| Pulse width                | 100 p | -   | 100 n | s               |
| Rise / Fall time           | -     | 40  | -     | ps              |

## DC Electrical Characteristics

| Parameter              | Symbol     | Min | Typ  | Max | Unit |
|------------------------|------------|-----|------|-----|------|
| Supply voltage (fixed) | $V_{bias}$ | 9   | 12   | 13  | V    |
| Driver Supply Current  | $I_{bias}$ | -   | 300  | 400 | mA   |
| Gain control voltage   | $V_{amp}$  | 0   | 0.25 | 0.9 | V    |

## Electrical Characteristics

| Parameter                  | Symbol            | Condition                        | Min   | Typ       | Max   | Unit            |
|----------------------------|-------------------|----------------------------------|-------|-----------|-------|-----------------|
| Lower frequency            | $f_{3dB, lower}$  | -3 dB point                      | 45    | 50        | -     | kHz             |
| Upper frequency            | $f_{3dB, upper}$  | -3 dB point                      | 6     | 8         | -     | GHz             |
| Gain                       | $S_{21}$          | Small signal, $P_{in} = -30$ dBm | -     | 21        | -     | dB              |
| Gain ripple                | -                 | < 7 GHz                          | -     | $\pm 1.5$ | -     | dB              |
| Input / Output return loss | $S_{11} / S_{22}$ | 50 kHz < $f$ < 10 GHz            | -     | -10       | -     | dB              |
| Output pulse amplitude     | $V_{out}$         | $V_{in} = 300$ mV <sub>pp</sub>  | 2.5   | 5         | 8     | V <sub>pp</sub> |
| Sat output pulse amplitude | $V_{out}$         | $V_{in} = 500$ mV <sub>pp</sub>  | -     | -         | 8.5   | V <sub>pp</sub> |
| Pulse repetition frequency | PRF               | 100 ps < PW < 100 ns             | 10    | -         | 1 G   | Hz              |
| Pulse width                | PW                | 10 Hz < PRF < 1 GHz              | 100 p | -         | 100 n | s               |
| Rise / Fall time           | $t_r / t_f$       | 20 % - 80 %                      | -     | 25        | 30    | ps              |
| Delay time                 | $D_t$             | -                                | -     | 400       | -     | ps              |
| Power dissipation          | P                 | -                                | -     | 3.6       | 5.2   | W               |

Conditions: S parameters -30 dBm,  $T_{amb} = 25^\circ\text{C}$ , 50  $\Omega$  system

## Absolute Maximum Ratings

Stresses in excess of the absolute maximum ratings can cause permanent damage to the device. These are absolute stress ratings only. Functional operation of the device is not implied at these or any other conditions in excess of those given in the operational sections of the data sheet. Exposure to absolute maximum ratings for extended periods can adversely affect device reliability.

| Parameter                | Symbol     | Min | Max | Unit             |
|--------------------------|------------|-----|-----|------------------|
| RF input voltage         | $V_{in}$   | -   | 0.5 | V <sub>pp</sub>  |
| Supply voltage           | $V_{bias}$ | 0   | 13  | V                |
| DC current               | $I_{bias}$ | 0   | 400 | mA               |
| Gain control voltage     | $V_{amp}$  | 0   | 0.9 | V                |
| Power dissipation        | $P_{diss}$ | -   | 5.2 | W                |
| Temperature of operation | $T_{op}$   | -5  | +50 | $^\circ\text{C}$ |
| Storage temperature      | $T_{st}$   | -40 | +70 | $^\circ\text{C}$ |

**S<sub>21</sub> Parameter Curve**

Conditions:  $V_{bias} = 12\text{ V}$ ,  $V_{amp} = 0.47\text{ V}$ ,  $I_{bias} = 350\text{ mA}$

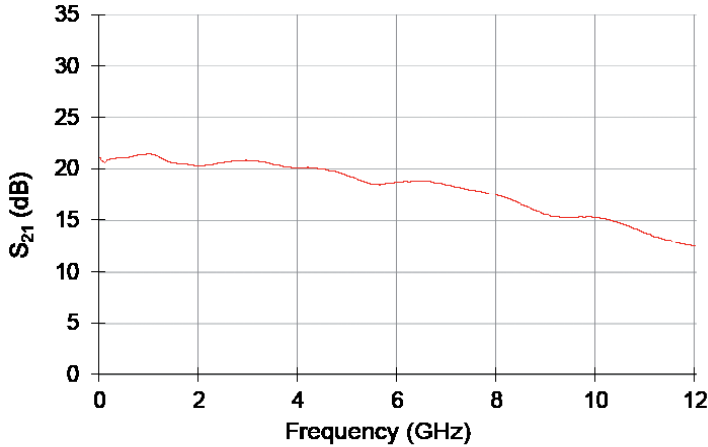

**Group Delay Parameter Curve**

Conditions:  $V_{bias} = 12\text{ V}$ ,  $V_{amp} = 0.47\text{ V}$ ,  $I_{bias} = 350\text{ mA}$

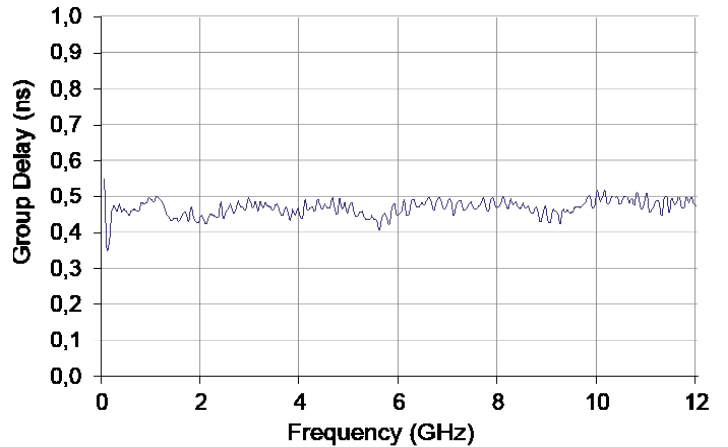

**S<sub>22</sub> Parameter Curve**

Conditions:  $V_{bias} = 12\text{ V}$ ,  $V_{amp} = 0.47\text{ V}$ ,  $I_{bias} = 350\text{ mA}$

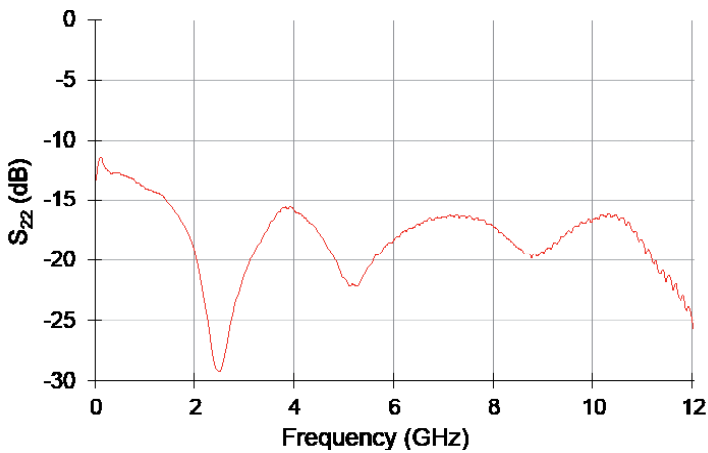

**S<sub>11</sub> Parameter Curve**

Conditions:  $V_{bias} = 12\text{ V}$ ,  $V_{amp} = 0.47\text{ V}$ ,  $I_{bias} = 350\text{ mA}$

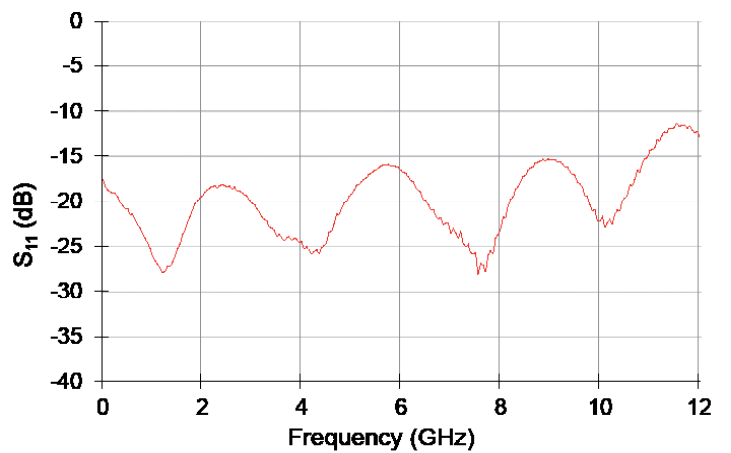

**S<sub>12</sub> Parameter Curve**

Conditions:  $V_{bias} = 12\text{ V}$ ,  $V_{amp} = 0.47\text{ V}$ ,  $I_{bias} = 350\text{ mA}$

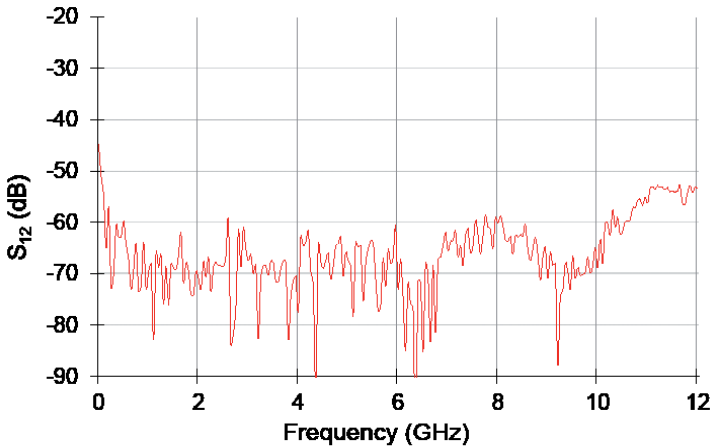

**Typical Output Voltage Amplitude vs V<sub>amp</sub>**

Conditions:  $V_{bias} = 12\text{ V}$ ,  $V_{in} = 0.3\text{ V}_{pp}$

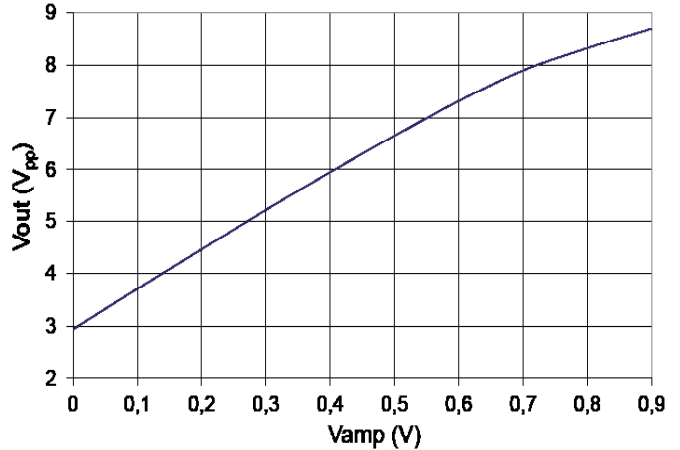

Pulses Measurements

Conditions: Input signal

The input electrical signal is generated by Anritsu MP1800A. Measured using Agilent 86100B with two 50 GHz 8348A channels module, and the output optical signal measured using Agilent 86100B with two 50 GHz 8348A channels module.

Low frequency repetition rate width wide pulse width: PW = 100 ps, PRF = 100 MHz

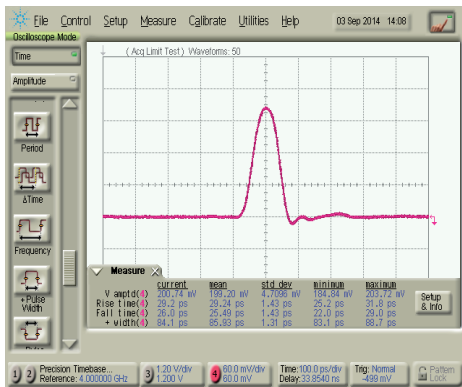

Input signal: Pulse amplitude = 0.200 V<sub>pp</sub>, Rise time = 29 ps

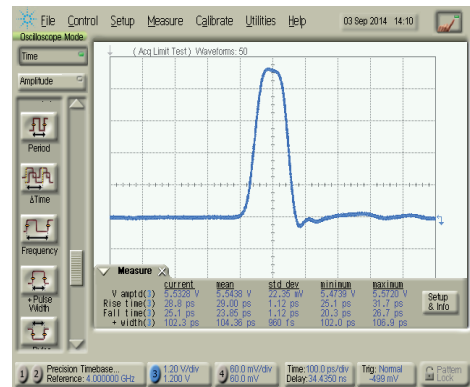

Output response: Pulse amplitude = 5.5 V<sub>pp</sub>, Rise time = 29 ps

Short frequency repetition rate with medium pulse width: PW = 5 ns, PRF = 10 kHz

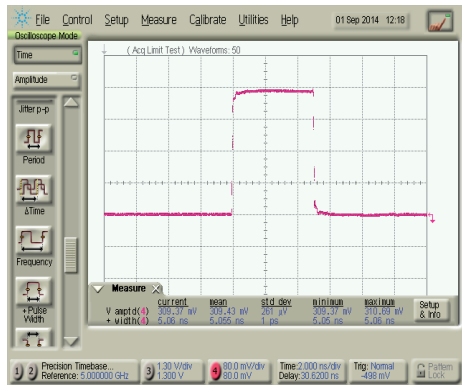

Input signal: Pulse amplitude = 0.31 mV<sub>pp</sub>, Rise time = 16 ps

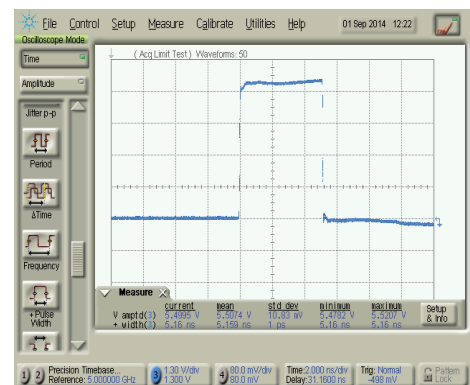

Output response: Pulse amplitude = 5.5 V<sub>pp</sub>, Rise time = 24 ps

Short frequency repetition rate with long pulse width: PW = 200 ps, PRF = 20 MHz

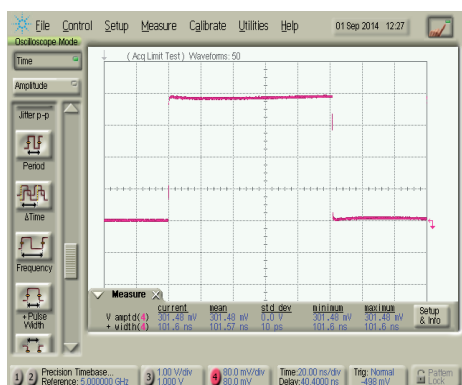

Input signal: Pulse amplitude = 0.37 mV<sub>pp</sub>, Rise time = 16 ps

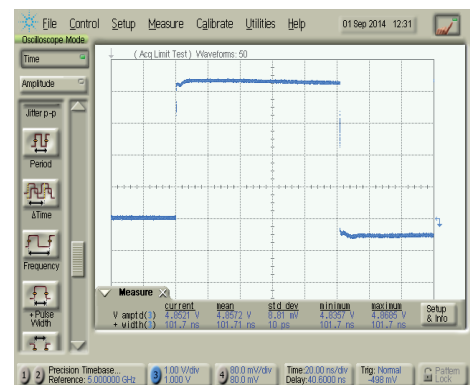

Output response: Pulse amplitude = 4.8 V<sub>pp</sub>, Rise time = 24 ps

Electrical Schematic Diagram

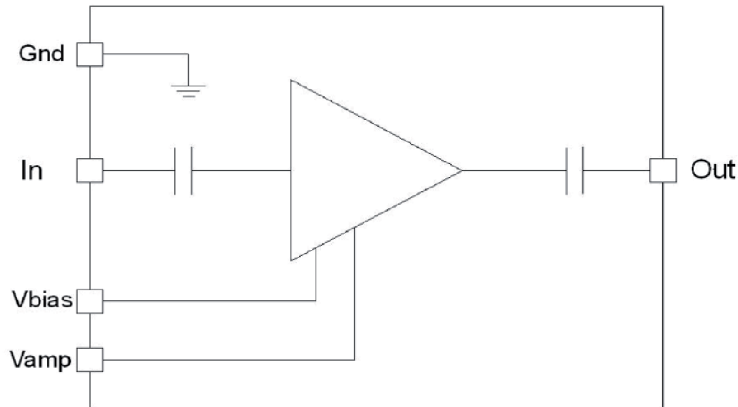

Mechanical Diagram and Pinout  
All measurements in mm

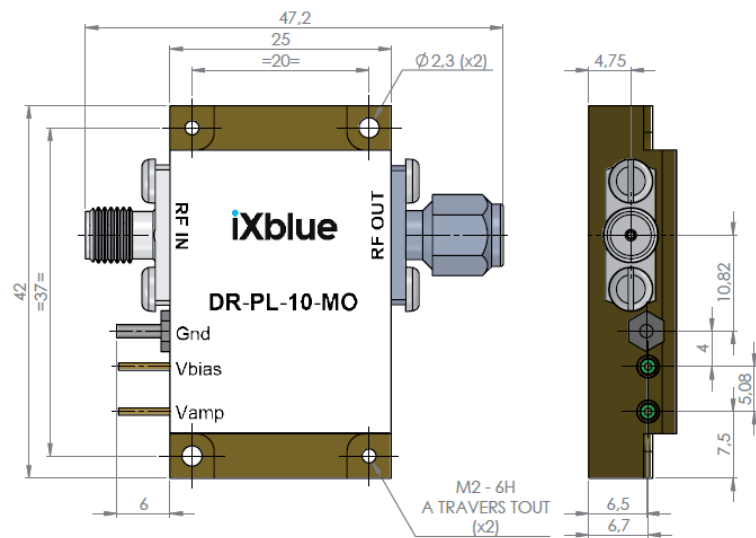

The heatsinking of the module is necessary. It's user responsibility to use an adequate heatsink. Refer to page 6 for ixBlue recommended heatsink.

| PIN        | Function                            | Operational Notes                      |
|------------|-------------------------------------|--|
| IN         | RF In                               | SMA-connector female                   |
| OUT        | RF Out                              | SMA-connector male                     |
| $V_{bias}$ | Power supply voltage                | Set at typical operating specification |
| $V_{amp}$  | Output voltage amplitude adjustment | Adjust for gain control tuning         |

Mechanical Diagram And Pinout With HS-HO1 Heatsink

All measurements in mm

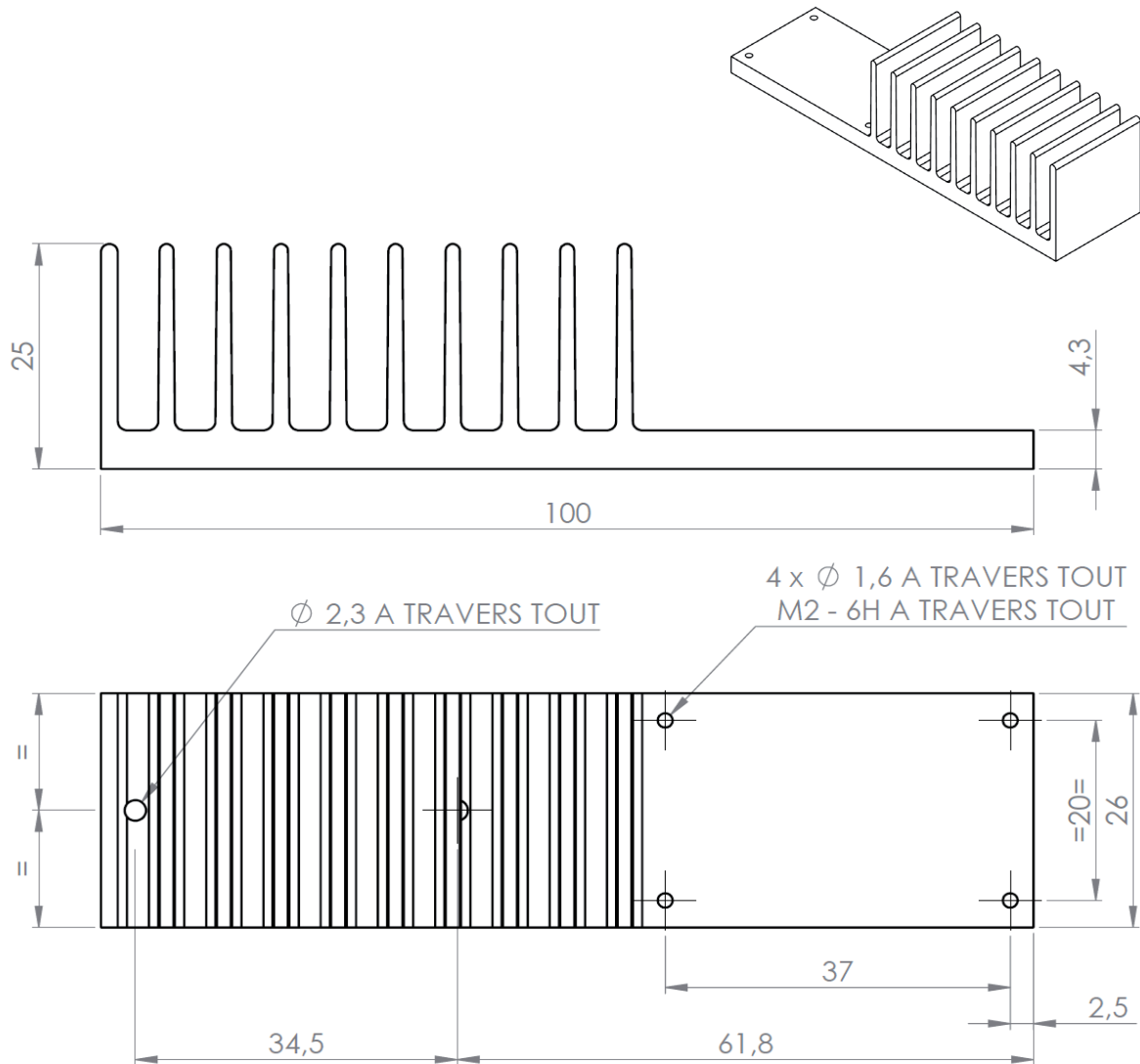

About us

ixBlue Photonics produces specialty optical fibers and Bragg gratings based fiber optics components and provides optical modulation solutions based on the company lithium niobate (LiNbO<sub>3</sub>) modulators and RF electronic modules.

ixBlue Photonics serves a wide range of industries: sensing and instruments, defense, telecommunications, space and fiber lasers as well as research laboratories all over the world.

3, rue Sophie Germain  
25 000 Besançon - FRANCE  
Tel. : +33 (0) 381 853 180 - Fax : + 33 (0) 381 811 557

ixblue reserves the right to change, at any time and without notice, the specifications, design, function or form of its products described herein. All statements, specification, technical information related to the products herein are given in good faith and based upon information believed to be reliable and accurate at the moment of printing. However the accuracy and completeness thereof is not guaranteed. No liability is assumed for any inaccuracies and as a result of use of the products. The user must validate all parameters for each application before use and he assumes all risks in connection with the use of the products